

REV	DATE	MODIFICATION	DRAWN
A	2018/07/02		

SPECIFICATIONS

1. ELECTRICAL:
 - UL APPLICATIONS: 250 VOLTS AC MAX. AT 2 AMPS.
 - DIELECTRIC WITHSTANDING VOLTAGE : 1000 VOLTS AC. 60 SEC.
 - INSULATION RESISTANCE: 500 MΩ.
 - CONTACT RESISTANCE: 20mΩ MAX.
 - OPERATING AMBIENT TEMPERATURE: -40°C ~ 70°C.
2. MECHANICAL:
 - STRAIN RELIEF: 20POUND MIN.
 - DURABILITY: 1200 MATING CYCLES.
3. MATERIAL:
 - HOUSING: POLYCARBONATE, UL94V-0 OR UL94V-2.
 - COLOR: TRANSPARENT OR OTHER COLOR ARE AVAILABLE.
 - CONTACT BLADE: COPPER ALLOY.
 - GOLD PLATING: 30"-50" , ARE AVAILABLE.
4. USAGE:
 - SUITABLE FOR STRANDED & SOLID WIRE 23AWG ~ 26 AWG.

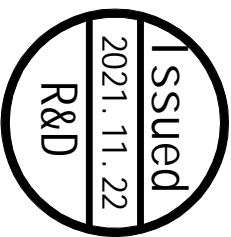
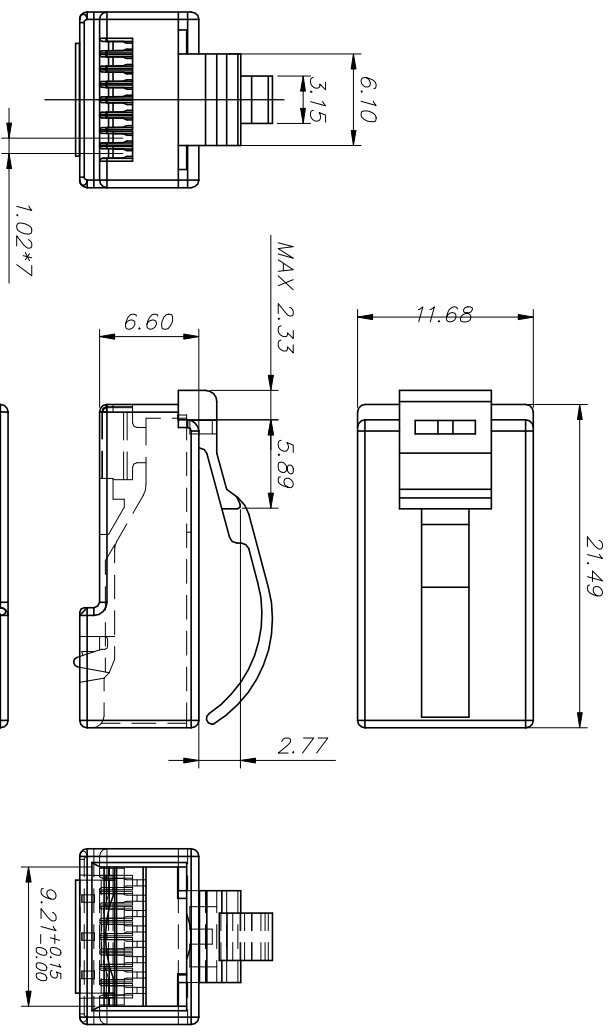

BLADE:	E	EB	Y	YB	Z	A	AE	AB
Drawing								
Mark					✓			

GOLD PLATING	3Mu "	3u "	6u "	15u "	30u "	50u "	CABLE TYPE	ROUND	FLAT
Mark						✓	Mark	✓	

EXW NINGBO EXCELLENCE COMMUNICATED CONNECTOR CO.,LTD

DIMENSION IN mm (Inch)	TOLERANCE UNLESS OTHERWISE SPECIFIED	MATERIAL	DWG NO.	TITLE
.X±0.20	.X±.5°	PC	PLUG-455-0002	C6RH5Z50V2IL
.XX±0.10	.XX±.2°			

APPROVAL	Cari ne	CHECKED	Zach	DRAWN	Zach	SCALE	2/1	SHEET	1/1
						PROL.		REV	A

REV	DATE	MODIFICATION	DRAWN
C	2012/08/15		Zach

Issued
 2021. 11. 22
R&D

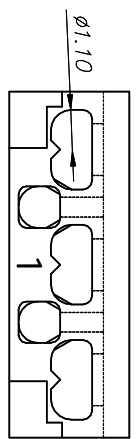
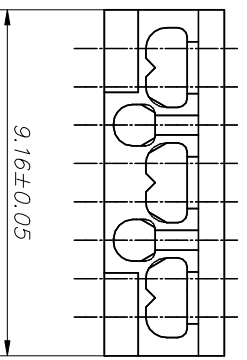
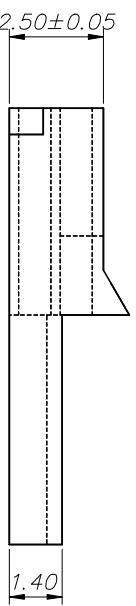
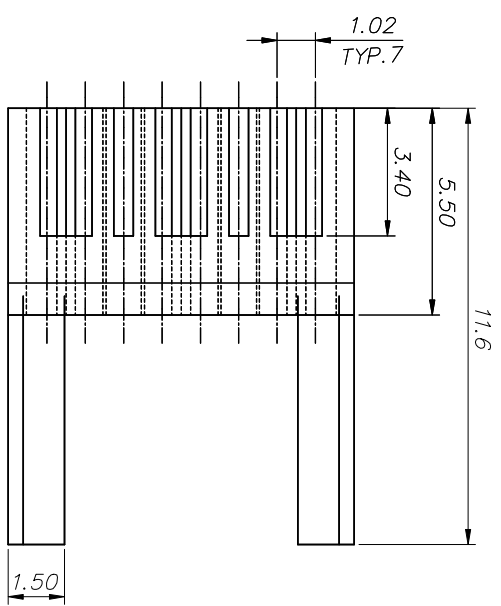

(It can be used for the wire OD from Ø 0.98~Ø1.05)

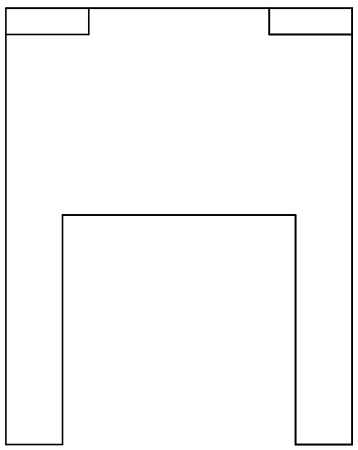

EXW		NINGBO EXCELLENCE COMMUNICATED CONNECTOR CO.,LTD	
DIMENSION IN mm (Inch)		MATERIAL	DWG NO.
TOLERANCE UNLESS OTHERWISE SPECIFIED		PC	PLUG INSERT-027A
.X±0.20	.X±.5°	TITLE	C6 INSERT 1.1
.XX±0.10	.XX±.2°		
APPROVAL	CHECKED	DRAWN	SCALE
Carine	Zach	LiWenjuan	5/1
			PROL.
			REV
			SHEET
			1/1
			C

ST - DR - 009A